

Pavilion (50HZ) OWNER'S MANUAL

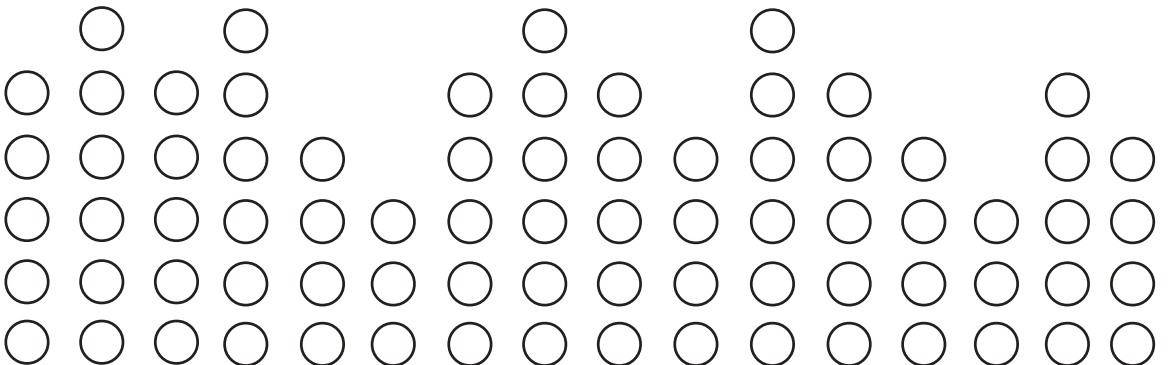

Model: _____
 Serial Number: _____
 Date Installed: _____
 Dealer: _____
 Address: _____
 Telephone: _____

Note: The serial number/identification label is located within the equipment compartment and skimmer housing.

Model	Average Fill Gallons	Weight Filled lbs.	Weight Empty lbs
#8000 - Pavilion	525	5084	800

Thank you for your recent Saratoga Spa Purchase.

This owners manual has been designed to acquaint you with your Saratoga Spa's operation and general maintenance.

Keep this manual available for future reference.

If you have any questions regarding your Saratoga Spa, contact your local dealer.

Thank you.





Table of Contents

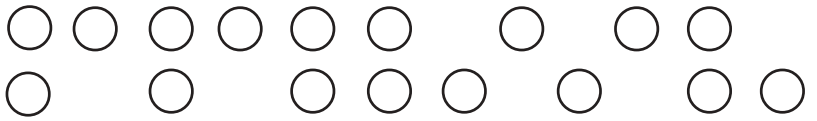

SARATOGA SPA SAFETY INSTRUCTIONS

- Avoiding Risk to Children 2
- Avoiding Risk of Electrical Shock 3
- Avoiding Risk of Injury 3
- Unclean Water 4
- Avoiding Risk of Hyperthermia 4
- Avoiding Risk of Skin Burns 4
- Important Spa Instructions 5

- Pavilion Specifications 5-6

INSTALLATION INSTRUCTIONS

- Location Preparation 7
- Outdoor Installation 7
- Indoor Installation 7

ELECTRICAL REQUIREMENTS AND PRECAUTIONS

- 220 Volt Permanently Connect Models 8
- Electrical Installation Instructions
- 220 Volt Models 8
- Electrical Spa Wiring Connection Instructions
- 220 Volt Models 9

INITIAL OPERATING INSTRUCTIONS

- Start-up and Re-fill Procedures 10
- Start-up Procedures 11

JET SYSTEM

- Saratoga Spa Jet Identifications 13
- Saratoga Spa Jet Selectors 15
- Jet Therapy Zones 16
- Pavilion 17-18

EQUIPMENT MAINTENANCE

- Jet Selector Maintenance 19
- Light Bulb Replacement 19

CONTROL PANEL OPERATION

- Main Panel 20
 - Temperature Control 20
 - Setting the Time 21
 - Operating the Hydro Pumps 21
 - Invert 22
 - Freeze Protection 22
- Main Control Panel Locking Features 22
 - Major Spa Panel Lock 22
 - Minor Temperature Lock 22

SPA CARE AND WATER MAINTENANCE

- General Information 23
- Care of Pillows 24
- Care of Exterior 24
- Care of Spa Cover 25
- Winterizing your spa 26
- Water Quality Maintenance 27-29
- Troubleshooting Guides 30-31
- Diagnostic Messages 32-33
- System Connections and Fuses 34
- Wiring Diagram 35
- Dip Switches and Jumpers 35
- Replacement Parts 36
- Accessories 36
- Spa Care and Maintenance Record 37

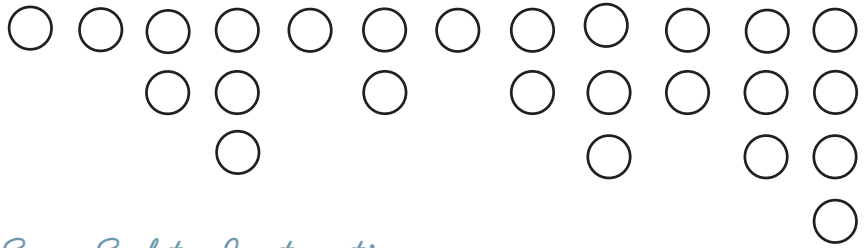

Saratoga Spa Safety Instructions

READ AND FOLLOW ALL INSTRUCTIONS AVOIDING THE RISK TO CHILDREN SPA SAFETY REMINDERS

DANGER:

• **RISK OF CHILD DROWNING.** Extreme caution must be exercised to prevent unauthorized access by children. To avoid accidents, ensure that children cannot use a spa unless they are supervised at all times.

WARNING:

- To reduce the risk of injury, do not permit children to use this spa unless they are closely supervised at all times.
- To reduce the risk of injury, lower water temperatures are recommended for young children. Children are especially sensitive to hot water.

DO:

- Make sure you always lock the child resistant locks after using the spa for your children's safety. Every Saratoga Spa is equipped with a locking cover that meets the ASTM F1346-91 Standard for Safety Covers.
- Test the water temperature with your hand before allowing children to enter the spa to be sure that it's comfortable. Children are especially sensitive to hot water.
- Remind children that wet surfaces can be very slippery. Make sure that children are careful when entering or exiting the spa.

DON'T:

- Allow children to climb onto the spa cover.
- Allow children to have unsupervised access to the spa.

AVOIDING THE RISK OF ELECTROCUTION

Risk of electrocution

- Connect only to a grounded source.
- Do not bury the power cord. A buried power cord may result in death, or serious personal injury due to electrocution if direct burial-type cable is not used, or if improper digging occurs.
- A ground terminal (pressure wire connector) is provided on the control box inside the unit to permit connection of a minimum No. 8 AWG (8.4 mm) solid copper bonding conductor between this point and any metal equipment, metal water pipe, metal enclosures of electrical equipment, or conduit within five feet (1.5 m) of the unit as needed to comply with local requirements.

WARNING:

• To reduce the risk of electrical shock, replace a damaged cord immediately. Failure to do so may result in death or serious personal injury due to electrocution.

DANGER - Risk of electric shock. Do not permit any electrical appliance, such as a light, telephone, radio or television within 5 feet (1.5m) of a spa. These units DO NOT have an internal ground fault circuit interrupter. The installation of a ground fault circuit interrupter MUST be done by a qualified Electrician and must meet all local and national codes.

DANGER: RISK OF ELECTRICAL SHOCK

- Install at least 5 feet (1.5 m) from all metal surfaces. A spa may be installed within 5 feet of a metal surface if each metal surface is permanently connected by a minimum No. 8 AWG (8.4 mm) solid copper conductor attached to the wire ground connector on the terminal box that is provided for this purpose if in accordance with National Electrical Code ANSI/NMFA70-1993.
- Do not permit any electrical appliances, such as a light, telephone, radio, or television within 5 feet (1.5 m) of a spa. Failure to maintain a safe distance may result in death, or serious personal injury due to electrocution, if the appliance should fall into the spa.
- Install your spa in such a way that drainage is away from the electrical compartment and from all electrical components.

DO:

- Do test the water temperature with your hand before entering the spa to be sure the water temperature is comfortable.
- Do keep the spa cover locked when the spa is not in use.
- Do check the equipment compartment monthly for any signs of tampering to the spa equipment.
- Do follow the maintenance instructions of the spa found in this owner's manual.
- Be sure your spa is connected to the power supply correctly - use a licensed electrical contractor.
- Test the Ground Fault Circuit Interrupter(s) once a month.

DON'T:

- Use the spa with the equipment compartment door removed.
- Place electrical appliances within 5 feet (1.5m) of the spa.
- Don't allow children to have unsupervised access to the spa.
- Don't block the equipment compartment vents. This could cause damage to the spa equipment and will void the warranty.

RISKS TO AVOID

DANGER: RISK OF INJURY

- To reduce the risk of injury to persons, DO NOT remove suction fittings located at the bottom footwells of the spa.
- The suction fittings in the spa are sized to match the specific water flow created by the pump. Never replace a suction fitting with one rated less than the flow rate marked on the original suction fitting. Never operate the spa if the suction fittings are broken or missing.
- There is a danger of slipping and falling. Remember that wet surfaces can be very slippery. Take care when entering or exiting the spa.
- People with infectious diseases should not use the spa.
- Keep any loose articles of clothing or hanging jewelry away from rotating jets or other moving components.
- The use of drugs, alcohol, or medication before or during spa use may lead to unconsciousness with the possibility of drowning.

- Persons using medications should consult a physician before using a spa; some medication may cause a user to become drowsy, while other medication may affect heart rate, blood pressure, and circulation.
- Persons taking medications which induce drowsiness, such as tranquilizers, antihistamines or anticoagulants should not use the spa.
- Water temperature in excess of 38°C (100.4°F) may be injurious to your health.
- Pregnant women should consult a physician before using spa.
- Persons suffering from obesity, or with a medical history of heart disease, low or high blood pressure, circulatory system problems, or diabetes should consult a physician before using spa.

UNCLEAN WATER

- Keep the water clean and sanitized with correct chemical care.
- Maintain water chemistry in accordance with manufacturer's instructions.

IMPORTANT: Turn on Jet Pump #1, on high speed, for at least ten minutes after adding ANY spa water chemicals into the spa.

- Clean the filter cartridges monthly to remove debris and mineral buildup which may affect the performance of the jets, limit the flow, or trip the high limit thermostat.

AVOID THE RISK OF HYPERTHERMIA

The causes, symptoms and effects of hyperthermia may be described as follows: Hyperthermia occurs when the internal temperature of the body reaches a level several degrees above the normal body temperature of 98.6°F. The symptoms of hyperthermia include an increase in the internal temperature of the body, dizziness, lethargy, drowsiness and fainting. The effects of hyperthermia include: 1. Failure to perceive heat. 2. Failure to recognize the need to exit the spa or hot tub. 3. Unawareness of impending hazard. 4. Fetal damage in pregnant women. 5. Physical inability to exit the spa or hot tub. 6. Unconsciousness resulting in drowning.

WARNING:

The use of alcohol, drugs, or medication can greatly increase the risk of fatal hyperthermia in hot tubs and spas.

TO REDUCE THE RISK OF INJURY:

- The water in the spa should never exceed 104°F (40°C). Water temperatures between 100°F (37.7°C) and 104°F (40°C) are considered safe for a healthy adult.

Lower water temperatures are recommended for extended use (exceeding ten minutes) and for young children. Extended use can cause hyperthermia.

- Pregnant or possibly pregnant women should limit spa water temperatures to 100°F. Failure to do so may result in permanent injury to your baby.
- Do not use spa immediately following strenuous exercise.

AVOIDING THE RISK OF SKIN BURNS:

- To reduce the risk of injury, before entering a spa the user should measure the water temperature with an accurate thermometer, since the tolerance of temperature-regulating devices may vary by as much as ±5°F.
- Test the water with your hand before entering the spa to be sure it's comfortable.

IMPORTANT SPA INSTRUCTIONS

The following contains important spa information, and we strongly encourage you to read and apply them.

DO:

- Use and lock the vinyl cover when the spa is not in use, whether it is empty or full.
- Follow the Spa Care and Maintenance recommendations stated in this manual.
- Use only approved accessories and recommended spa chemicals and cleaners.

DON'T:

- Leave the Saratoga spa exposed to the sun without water or the cover in place. Exposure to direct sunlight can cause solar distress of the shell material.
- Lift or drag the vinyl cover by using the cover lock straps; always lift or carry the cover by using the handles.
- Attempt to open the electrical control box. There are no user serviceable parts inside. Opening of the control box by the spa owner will void the warranty. If you have an operational problem, carefully go through the steps outlined in the Troubleshooting section. If you are not able to resolve the problem, contact your authorized Saratoga Spa dealer. Many problems can easily be diagnosed over the telephone by an Authorized Service Technician.
- Block or sit on the filter compartment area.
- Allow excessive weight to be placed on the spa cover. Doing so could damage the spa cover and void any warranty.

SAVE THESE INSTRUCTIONS

Spa Specifications

	Width	Height	Length	Average Fill	Dry Weight	Average Full Weight	Seating Locations
Pavilion	89" 2,26m	38" 0,96m	93" 2,36m	525 gal 1987L	800 lbs. 363 kg	5084 lbs. 2306 kg	6-8 6-8

CAUTION: Saratoga Spa Company suggests a structural engineer or contractor be consulted before the spa is placed on an elevated deck.

* **NOTE:** The "Average Full" weight of the spa includes only the spa and the water inside the spa.

Pavilion - Spa

Features

- A. Versa-Flo™ Valves
- B. Roto Stream™ Valves
- C. Power Massage® Jets
- D. Power Stream® Jets
- E. Cluster Jets
- F. Mini Jets
- G. Deluxe Jet
- H. Storm Jets
- I. Turbo Jets
- J. Vortex™ Circulation Jet
- K. Relax Stream™ Waterfall
- L. Bottom Spa Drain
- M. Backlit Digital Control Panel
- N. Microban® Filtration
- O. Topping Skimmer
- P. Pillows
- Q. Mood Light

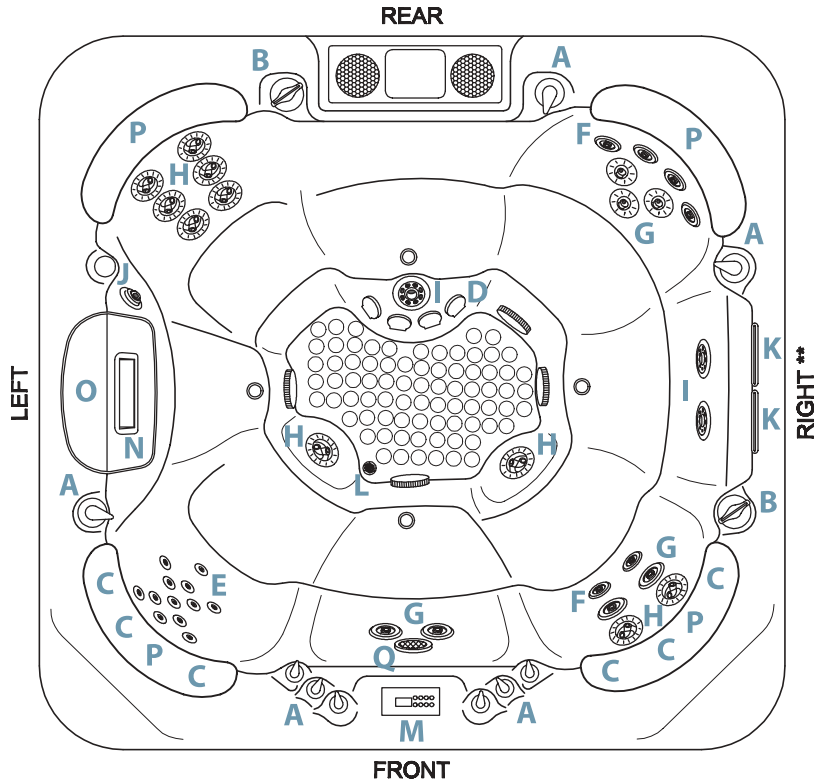

Pavilion - Saratoga Spa

Operations Center

1. 3 Uni Speed Hydro Pumps
2. Heater 3kw
3. Purity® Circulation Pump
4. 220V Power Pak
5. Whisper Zone Ozonator
6. Drain Valve
7. Mood light
8. Bonding Terminal

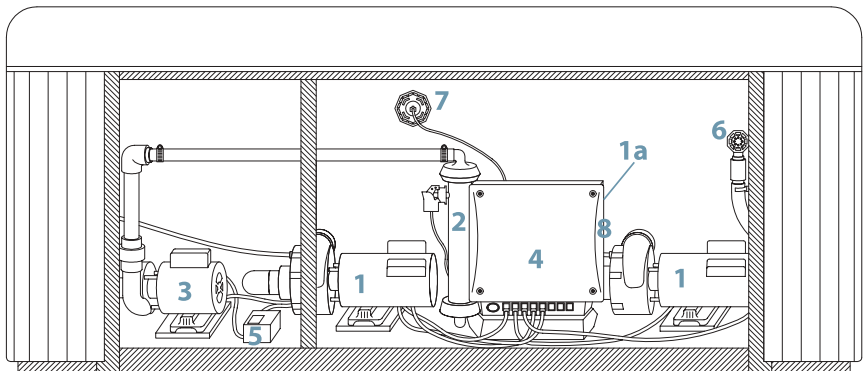

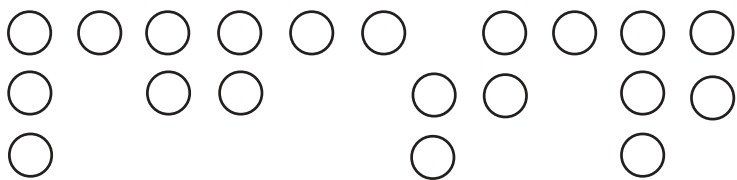

Installation Instructions

Location Preparation

Your Saratoga Spa is totally self-contained and portable. You can install the spa outside or inside. Preferable places are on a patio, deck or indoors. The spa should always be placed on a structurally strong, level surface. Other items you need to consider are the following:

- Verify that the location chosen can support the weight of the spa, the water of the spa and its occupants.
- Always check the surface of the site to see if it is level before filling the spa with water.
- Allow access to the equipment compartment for routine maintenance.
- When positioning the spa, be sure to allow for drainage away from the electrical compartment.
- Leave easy access to the RCI breaker.

WARNING: The Saratoga Spa is manufactured to be a portable unit. Any permanent installation of this product is done at the risk of the owner. Permanent installation of this unit violates warranty coverage.

Outdoor Installation

Always keep in mind what type of climate you live in. In a climate with cold, snowy winters you may want to consider locating the spa close to the house for easy access. In climates where it is normally warm or hot year-round, it would be recommended to place the spa in a shaded or cool area.

With deck installations it is recommended that a qualified building contractor or structural engineer review the weight the deck can support. The spa specification sheet (on page 6) can assist you with the weights and dimensions of your spa.

Indoor Installation

Special requirements are needed for indoor installation. Spas normally produce moisture. A ventilation system needs to be considered. Your spa area should contain moisture resistant wall/floor coverings and building materials to avoid damage from moisture over time. Proper drainage of the spas water also needs to be considered.

IMPORTANT: Your Saratoga Spa is equipped with air vents to allow for circulation of air throughout the equipment compartment. These vents are found on the face of the equipment compartment panel and under the corners of the spa at the equipment compartment end. Do not allow vents to be blocked as to prevent the circulation of air in the equipment compartment.

YOUR SARATOGA SPA DEALER CAN HELP YOU WITH INFORMATION SUCH AS LOCAL ZONING REGULATIONS AND BUILDING CODES.

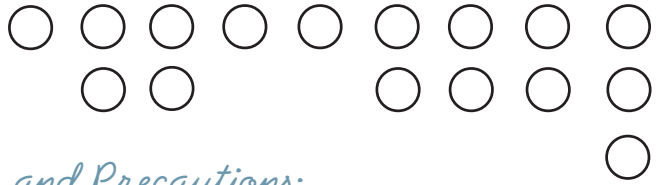

Electrical Requirements and Precautions:

Your Saratoga Spa has gone through numerous tests to verify that all the spas functions operate. Beyond the tests, your Saratoga Spa has been designed to provide the maximum safety against electrical shock. Read and follow the electrical installation requirements and instructions completely. The next few pages will assist you in properly connecting the electrical input. Follow the electrical instructions for your specific spa model. Serious risks or injuries may occur if the spa is improperly wired.

220 Volt Permanently Connected Model:

-Pavilion

SARATOGA SPAS MUST BE WIRED IN ACCORDANCE WITH ALL APPLICABLE LOCAL ELECTRICAL CODES. ALL ELECTRICAL WORK SHOULD BE DONE BY AN EXPERIENCED, LICENSED ELECTRICIAN. WE RECOMMEND THE USE OF APPROPRIATE ELECTRICAL CONDUIT, FITTINGS AND WIRE FOR ALL CIRCUITS.

220 Volt installations require a 50Hz, single phase, two-wire electrical service plus ground (Line 1, Neutral and Ground) and must be connected using a minimum supply conductor ampacity of 32 AMPs and a minimum circuit breaker size of 32 AMPs. Note: Use copper wire only (2-wire with ground. 8 gauge under 50', 6 gauge over 50')

220 Volt model spas must be connected to a "dedicated" 220 Volt 32 AMP grounded circuit. The term "dedicated" means the electrical current is not being used for any other electrical items (lights, appliances, etc.). If the spa is connected to a non-dedicated circuit, overloading will occur and nuisance tripping of the RCI breaker switch at the house breaker panel will occur.

A ground lug connector is provided on the exterior surface of the spa pack (operations center) inside the equipment compartment. This is to permit the connection of a bonding wire between this point and any metal equipment, enclosures, pipe or conduit within five feet of the spa. This bonding wire must be at least 8AWG solid copper wire.

CAUTION: Use only approved pressure-type wire splicing lugs or connectors suitable for the size and type of wiring used!

Electrical Installation Instructions for 220 Volt Models

1. To connect the electrical service, first remove the screws from the equipment compartment door. Carefully remove the access panel.
2. Locate the GL2000 spa control box. Loosen the screws on the front of the control box. Remove the screws and the control box cover.
3. Input the electrical service from the RCI breaker into the spa equipment compartment.

Note: The RCI breaker must be placed in sight of the spa at a minimum distance of five feet (1.5m) away.

Note: As of January 1, 1996 the National Electric Code (NEC) requires RCI on all spa installations.

Electrical Spa Wiring Connection Instructions

WIRING CONNECTIONS

1. Identify the TB-1 terminal block located inside the GL2000 control box on the left side.
2. Connect the 8 AWG BLACK wire from the RCI 32AMP breaker , terminal LI to TB-1, Line 1.
3. Connect the 8 AWG RED wire from the RCI 32AMP breaker; terminal N to TB-1, neutral.
4. Connect the 8 AWG GROUND wire from the RCI 32AMP breaker; terminal GND (ground) to TB-1, ground.
5. At least two additional lugs marked “Bonding Lugs” are provided on the external surface of one of the bonded components metal enclosures. To reduce the risk of electrical shock, connect the local common bonding grid in the area of the hot tub or spa to these terminals with an insulated or bare copper conductor not smaller than No. 6 AWG.
6. All field-installed metal components such as rail, ladders, drains or other similar hardware within 10 ft (3m) of the spa or hot tub shall be bonded to the equipment grounding bus with copper conductors not smaller than No. 6 AWG.
7. Replace the control box cover and securely tighten the fastening screws. Close and secure the equipment compartment panel.

Note: Always use copper wire only (3 wire with ground. 8 gauge under 50ft, 6 gauge over 50ft) The electrical supply for this product must include a suitable rated switch or circuit breaker to open all ungrounded supply conductors to comply with Section 422.20 of the National Electrical Code ANSI/NEPA 70-1987. The disconnecting means must be readily accessible to the tub occupant but installed at least 5 feet (1.5m) from tub water.

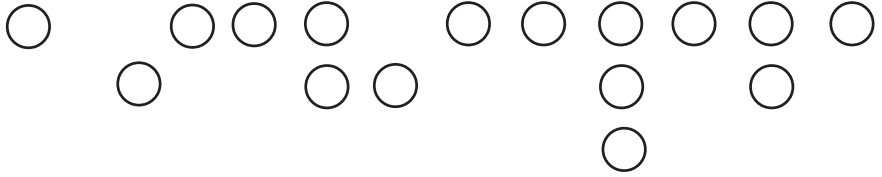

Initial Operating Instructions:

Start-Up and Refill Procedures

Your Saratoga Spa has been tested at the manufacturing plant to ensure that all the spas functions operate. During the test procedure, a small amount of water may have remained in the spas plumbing. Through the shipping process water may have spotted the spas shell. You may need to wipe down the shell with a soft cloth. Please read and follow the start-up instructions to ensure a successful start-up or refill.

CAUTIONS

- Inspect and clean spa shell from any debris
- Do not turn power on to spa unless filled with water to appropriate level. The spa pack must never be operated without water in the spa; serious damage to the heater and/or pump(s) may result.
- Do not fill spa with water before checking the items below (below items may become loose in transit):

a) Hand tighten unions at the pumps

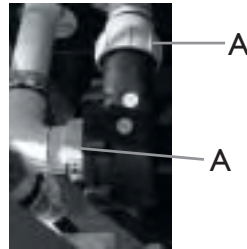

b) Tighten drain valve



Note: Drain Valve is left open for shipping - drain valve must be closed before filling spa.

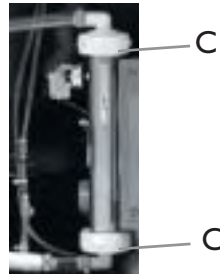

c) Tighten unions on heater

- Do not fill spa with hot water. This may cause a false error code to the high limit sensor.

Start-up Procedures

1. For a successful start-up, fill the spa with water through the Whisper Clean® cartridge. The Whisper Clean® cartridge is the cartridge with the coarse threaded ACME style adapter.

a. Locate the filter compartment area.



b. Pull up and remove filter cover.

c. Remove the filter cartridge and screen adapters by turning them counter clockwise.

d. After removing the filter cartridge and screen adapter, place a garden hose through the filter opening.

e. At this point, open the air bleeder valve(s) in your filter compartment by turning counter clockwise.



f. Turn water on and run water until it reaches a minimum level of 2" above the top of the filters.

NOTE: Besides filling the spa to 2" above the top of the filter, all models will need to be filled to 2" above the highest jet(s) in the spa. This is the minimum level allowed to run the Whisper Clean® circulation system.

NOTE: When using a mineral cartridge system, please refer to your dealer for specific instructions on installation.

2. Check all plumbing (clamps, unions and drain valve) connections for leaks.

3. Re-install filter cartridges and screen adapters by turning them clockwise. Exit garden hose from the spa.

4. At this point, turn power on to the spa control system by turning on the RCI breaker. The GL2000 pack control system will begin heating the spa to the factory set temperature of 100°F (37.5°C).

Note: When your spa is actuated, it will go into priming mode. Priming mode will last for 4

minutes then the spa will begin to heat. You may exit priming mode by pushing the Warm or Cool button.

5. The next step is to check that the jet system(s) are operational. Press on the Jet(s) button to turn on the pump(s). A strong force of water flowing through the jets indicates the pump(s) are primed. Weak or surging jet(s) indicates the pump(s) still need to be primed (see Troubleshooting section).

6. Once pump(s) are primed, close the air bleeder valve(s) in the filter compartment.

NOTE: Water will be exiting from the air bleeder valves.

7. Re-install filter cover and allow spa to heat to desired set temperature; this normally takes 24 hours.

*8. 24 hours after initial start-up the spa will go through its first power filtration cycle. Jet 1 (pump 1), Jets 2 (pump 2), Jets 3 (pump 3) will run on high speed for one (1) minute. This power filtration cycle is repeated every 24 hours at the exact same time of day as initial power-up.

NOTE: If water bubbles are not coming out of the bottom drain, the system is air bound. Refer to the Trouble Shooting section.

NOTE: It is recommended to press and release the ground fault circuit interrupter (RCI) RESET button monthly to verify RCI is working properly.

* **NOTE:** If power is interrupted, the filtration cycle will be reset

9. Water must be balanced and shocked upon start-up. See your dealer or pages 21-29 of this manual for details. This procedure must be repeated each time the spa is drained and refilled.

10. The Whisper Clean® jet

The Whisper Clean® jet is connected to the Whisper Clean® system. The jet induces temperature controlled water and ozone into the spas footwell 24 hours a day.

Service Note: A slow or non-moving Whisper Clean® jet may indicate that the filter cartridge pores are obstructed with dirt, body oils or calcification. Follow the filter cartridge cleaning procedures in this manual.



Versa-Flo™ Jets and CFE Jet Descriptions



Power Massage Plus®

Patented jet provides dual water massage to your neck or back from under the built-in headrest. The jet is controlled by a small selector valve, giving the bather total control.



Power Stream®

Underwater jet patterned after the Power Massage®. This jet runs a ribbon of water parallel to the surface of the spa body. Not found in all units.



Cluster Jet

The Cluster Jet provides a concentrated stream of water and air for precise pressure point areas.



Mini Swirl Jet

The Mini Swirl Jet has an adjustable eyeball for directional or rotational use. To change from directional to rotational, with finger, simply adjust inner nozzle to the rotating position.



Cyclo Swirl Jet

A larger version of the Mini Swirl Jet, this jet gives a mid-size rotational massage and pulsating massage. To change from directional to rotational, with finger, simply adjust inner nozzle to the rotating position.



Cyclo Flo Jet

This jet provides a mix of water and air in a whirly pattern. To increase the whirly pattern, move inner nozzle to the outer position.



Twin Rotational Jet

This jet provides multiple adjustment for varied rotational intensities.



Turbo Jet

Provides an intense lower body massage and whirlpool stimulation through a large orifice.



Xtreme Flo Jet

The Xtreme Flo jet provides a mix of water and air. To change from a straight stream to directional, with finger, move inner nozzle to position desired.



Gatling Jet

A rotating dual nozzle, diffused by seven holes, creates a pulsating body massage.



Veri Massage Jet

Multiple pressure point profiles, providing foot and large muscle relief.

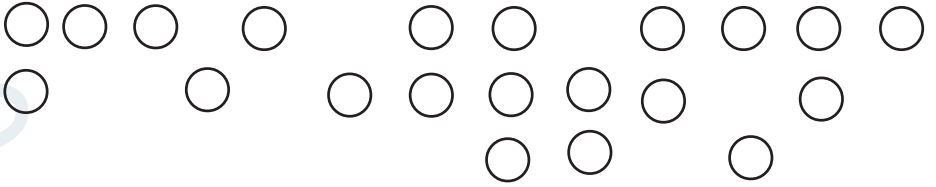

Saratoga Spa Jet Selectors

The Jets in the Saratoga Spa Luxury Line have different ways to adjust the jet therapy systems. While having the Hydro Jet pump(s) on the user has the ability to turn on and off each individual Versa-Flo™ Jet(s). The Versa Flo™ Jet(s) can be turned on and off by turning the outer scallop on the face of the jet. In addition to having the ability to control each individual jet, the jets can be adjusted by zones. Saratoga Spa uses three different ways to adjust the jet therapy zones. The Roto Stream™ Valves, Versa-Flo™ Selectors, and CFE Selectors give the user the ability to control the different Jet Therapy Zones. The following pages will discuss the different jet therapy zones found in the Pavilion Spa.



Versa-Flo™ or CFE Selector



Versa-Flo™ Selector



Roto Stream™ Selector



Roto Stream™ Selector

Jet Therapy Zones

This example will help you to understand the following pages that discuss the jet system menus. The navigational tool was read from standing outside of the spa and in front of the particular selector. Keep this in mind when the following pages discuss 12,3,6 or 9 o'clock position settings. The Versa-Flo™ selector, and CFE selector can only be rotated 180°. The Roto Stream™ valve can be rotated 360°.

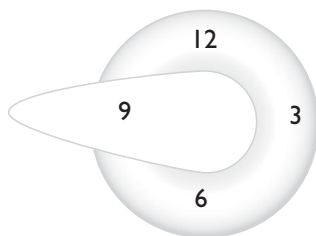

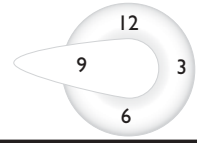

1 - ROTO STREAM™ VALVE

- Controls jets in seat 1.
- By rotating the Roto Stream™ valve allows the user to select the sequence best for them.

2 - ROTO STREAM™ VALVE

- Seat 2 is controlled in the same manner as seat 1, by using the Roto Stream™ valve.



3 - CFE SELECTOR

- controls two of the Power Massage® jets.



4 - SECONDARY CFE SELECTOR

- Controls the third Power Massage® jet.

5 - THIRD CFE SELECTOR

- The third CFE selector allows you to control one of the two Relax Streams™.
- By positioning the CFE selectors in the 3, 6, or 9 o'clock positions it gives the user the ability to turn on or off the jets discussed above.



6 - CFE SELECTOR

- The small CFE selector allows for control of the second Relax Stream™.

7 - SECOND CFE SELECTOR

- Controls one of the three Power Massage® jets.

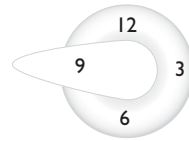

8 - THIRD CFE SELECTOR

• The third small CFE selector allows for adjustment of the other two Power Massage® jets.



9 - ROTO STREAM™ VALVE

• The Roto Stream™ valve controls the jets in seat 9. Rotating the Roto Stream™ valve allows the user to select the sequence best for them.



10 - VERSA-FLO™ SELECTOR

• Pointing the large Versa-Flo™ selector in the 9 o'clock position turns off the jets in seat 10. Positioning the Versa-Flo™ selector in the 3 o'clock position turns on the jets in seat 10.



11 - VERSA-FLO™ SELECTOR

• The large Versa-Flo™ selector controls zone 3. Turning the selector to the 12 o'clock position activates jets in zone the foot dome. Selector in 6 o'clock position turns on jets on side wall.

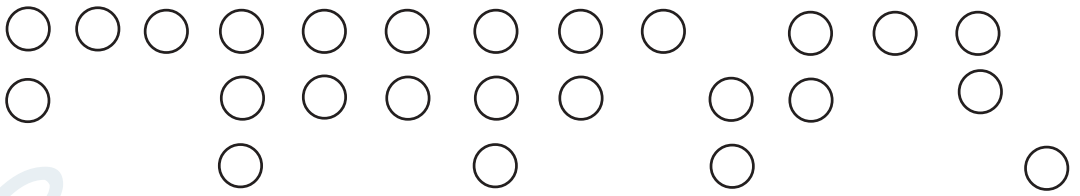

E

Equipment Maintenance

Saratoga Spa Jet Selector Maintenance

After a period of time it may become difficult to adjust and rotate the valves. It is necessary to clean the valves to ensure that they continue to perform well. The following instructions will walk you through the steps.

1. Turn power off to the spa.
2. Un-thread valve cover by turning valve cover counter clockwise.
3. Remove complete valve assembly, by pulling outward.
4. Clean or remove debris from valve or diverter.
5. Re-assemble and re-thread valve cover.



Replacing the Spa's Light Bulb

The spa's light bulb is located inside of the equipment compartment. Remove the front access panel, by first removing the screws on the access panel. Then locate the light housing mounted to the spa shell. Grasp the bulb holder on the back of the light niche. Turn bulb holder counter clockwise to release it from the light niche. Pull bulb out of receptacle and replace it with a new GE 912 bulb. Re-attach the light bulb holder to the light niche by turning the light bulb holder clockwise.

Note: colored lenses for the underwater mood light are an option.

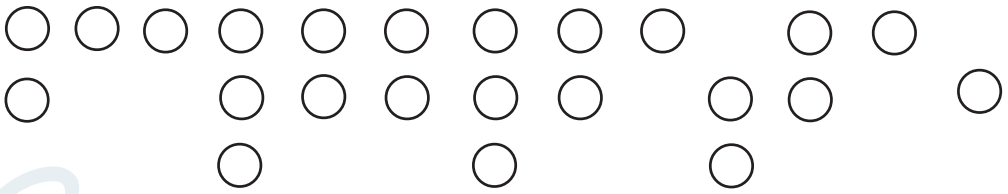

Control Panel Functions

Saratoga Spa models are equipped with a main control panel located on the top collar of the spa. The main control panel controls all of the spa functions. It displays the spa's status and any error messages. The main control panel and digital display are illuminated by a light from the inside of the panel.

Main Control Panel

The panel/topside will indicate the operations of the hydro jet pump(s), spa light, water temperature and will display diagnostic symbols.

Main Control Panel Buttons and Digital Display

The main control panel has buttons which the spa user presses to set the temperature, vary the intensity of the light and activate or deactivate the hydro jet pump(s). The control panel also has a digital display that displays the spas diagnostics (ie-temperature setting, jet functions or error messages).

TEMPERATURE CONTROL

The set temperature range is from 80°F (26°C) to 104°F (40°C). The set temperature of the spa water will automatically by 100°F (37.5°C) the first time that power is applied.

To display the set temperature of the spa, press the Cool or Warm button once. The set temperature will be displayed unless the control panel is locked.

To *increase* the set temperature of the spa water, press the Warm button twice. Pressing the button once will display the current set temperature. Pressing the button again will increase the set temperature by one degree.

To *decrease* the set temperature of the spa water, press the Cool button twice. Pressing the button once will display the current set temperature. Pressing the button again will decrease the set temperature by one degree.

Note: The temperature shown on the display without pressing on any of the temperature buttons reflects the temperature of the water at that particular moment.

Setting The Time

Once the spa has been properly connected the first time, notice the Time icon appearing on the screen.

Press  Then 

Select the hour by pressing  or  (Each press changes the time by 1 hour)

Press  to enter

Select minutes by pressing  or  (Each press changes the time by 1 minute)

Press  to exit the time setting procedure and enter the optional filter cycle programming.

Press  to exit programming.



Operating the Hydro Pumps

JETS 1 BUTTON

Activates the hydro jet pump for maximum jet action. Press Jets 1 button for high speed and again to turn off (Jets 1 wave icon will display when Jets 1 is on). Jets 1 will automatically shut off after 15 minutes of operation on low or high speed.

JETS 2 BUTTON

This button will activate the secondary hydro jet pump for additional hydrotherapy jet action. Press Jets 2 button once for high speed and again to turn off (Jets 2 wave icon will display when Jets 2 is on). Pump will automatically turn off after 15 minutes of operation.

JETS 3 BUTTON (OR BLOWER)

This button will activate the 3rd hydro jet pump. Press Jets 3 (Blower) button once for high speed and again for off position. Pump will automatically turn off after 15 minutes of operation.

LIGHT CONTROL BUTTON

Press the Light button to turn the spa light on and off.

STANDBY MODE

Pressing Warm or Cool then Jets 2 buttons will turn off all spa functions temporarily. This is helpful when changing a filter. Press any button to exit Standby mode.

INVERT

Press the Warm or Cool button followed by the Jets 3 (Blower) button to change the numbers of the display to read upside down.

FREEZE PROTECTION

If the temperature sensors detect a drop to 44°F (approximately 6.7°C) within the heater, the pump will automatically activate to provide freeze protection. The equipment stays on until 4 minutes after the sensors detect that the spa temperature has risen to 45°F (approximately 7.2°C) or higher. In colder climates, an optional additional freeze sensor may be added to protect against freeze conditions that may not be sensed by the standard sensors. Aux. Freeze sensor protection acts similarly except with the temperature thresholds determined by the switch and without a 4-minute delay in turnoff. See your dealer for details.

Note: Saratoga spas are designed for maximum heat retention. The unit is not designed to cool water. If the set or desired temperature is below that of the ambient temperature, the unit will not be able to achieve this demand. Depending on the desired temperature, it may be necessary to add cool water to the unit to lower your spas water temperature.

Locking Features

There are two locking features: Minor temperature Lock and Major Spa panel Lock. The locking features are enabled from the main control panel. Once a locking feature is enabled, that particular locking feature will remain until cancelled by the user.

MAJOR SPA PANEL LOCK

The Major Spa Panel Lock feature freezes all buttons except the Time button. To activate the Major Spa Panel Lock, press Time, Jets 1 and Warm buttons within 3 seconds. When locked, the PL indicator will light. To deactivate the Major Spa Panel Lock, press Time, Jets 1 then Cool buttons.

MINOR TEMPERATURE LOCK

The Minor Temperature Lock feature deactivates the temperature Warm or Cool buttons from the main control panel. All other functions on the main control will operate as normal. To activate, press Warm or Cool then Time, Jet 1 and Warm within 3 seconds. The TL indicator will light when the set temperature is locked. To unlock the set temperature, press Warm or Cool then Time, Jet 1 and Cool.

PL - Panel Lock



TL - Temperature Lock

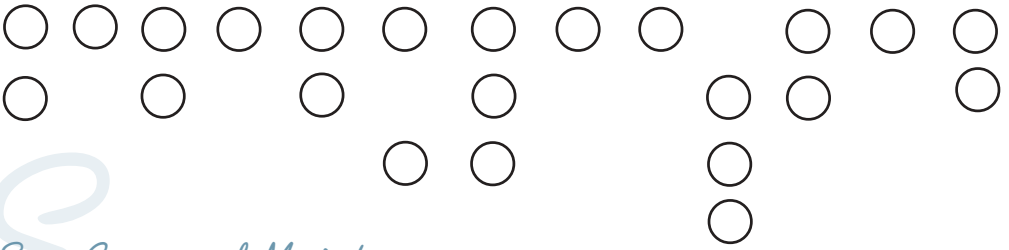

Spa Care and Maintenance

General Information

Your Saratoga Spa is manufactured from the highest quality, most durable materials available today. We recommend that a spa maintenance program be followed. The care you take will ultimately determine how long your spa or its individual components will last. This section will help you maintain your investment.

DRAINING THE WATER

It is recommended that you completely drain your spa every three to four months. Normally, after a period of time the water will become sudsy and harder to maintain and should be replaced.

TO DRAIN YOUR SPA:

1. Disconnect the spa from the power supply by tripping the RCI breaker located in the house breaker panel or at the RCI disconnect breaker at the spa.
2. Take off the equipment access panel by first removing the screws and then pulling out the access panel. Locate main drain valve and attach the inlet of a garden hose to the drain valve. Route garden hose to an appropriate draining area away from the spa to avoid flooding of the surroundings around the spa.

Note: Spa water with a high sanitizer level may harm plants and grass.

3. Open the drain valve by turning the knob. The spa will drain by gravitational flow.
4. Saratoga Spas will drain to the lower suction fittings in the footwell of the spa. It may be necessary to vacuum or sponge up a small amount of the remaining water in the spa.
5. When empty inspect the spa shell and clean as required.
6. Close the drain valve and remove garden hose.
7. Replace or close the equipment access door and replace screws.
8. Refill the spa through the filter compartment **BEFORE** restoring power.

IMPORTANT: Always clean the filter cartridges each time the spa is drained for cleaning.

FILTER SYSTEM

Saratoga Spas are equipped with three filter cartridges. As with any filtering system, the filter cartridges may become clogged with particles, body oils or calcification resulting in poor water quality and reduced water flow. It is important to maintain a clean, unobstructed filtering system. A reduced water flow may cause a false High Limit reading or cause the circulation pump to burn out or turn off. If the circulation of water stops during sub-freezing temperatures and goes unnoticed, the spa water may freeze, which is not covered under manufacturers warranties.

WARNING: *The frequency and duration of use, and the number of occupants, all contribute to determining the appropriate time between filter cleanings. More use means that more frequent filter cleanings are required. Failure to maintain the cartridges in a clean, unobstructed manner will result in reduced water flow. Any damage to the spa (due to freezing) caused as a result of poor maintenance will not be covered by your spa warranty.*

Filter Cartridge Removal and Cleaning

1. Disconnect the spa from the power supply by tripping the RCI breaker at the spa.
2. Remove and carefully set aside the filter compartment cover.
3. Remove any floating items from within the filter compartment.
4. Grasp the top of the filter cartridge and turn the cartridge counter clockwise until it is free from the base retainer. Leave screen adapter in place.
5. Place the cartridge on a clean surface and spray with a garden hose. It will be necessary to rotate the cartridge(s) to ensure all the filter pleats have been cleaned.
6. Continue cleaning by spraying down throughout the center of the cartridge (inside out).
7. For a complete and more thorough cleaning it is recommended to soak cartridges in a filter cleaning solution. Follow directions on the filter cleaner label.
8. Before inserting cartridges, do a final inspection of the cartridges.
9. To reinstall the filter cartridges, reverse the order in which the cartridges were removed.

WARNING: Do not use the spa with the filter cartridges or screen adapters removed!

NOTE: Spa cartridges are a disposable item and should be replaced each year.

CARE OF THE SPA PILLOWS

The spa pillows used on Saratoga Spa models will provide years of comfort if treated with care. To extend their life the spa pillows should be removed and cleaned. Wash with a mild soap and water solution. ALWAYS rinse off the spa pillows thoroughly to remove any soap residue. If the spa is not going to be used for a long period of time the spa pillows should be removed until the next spa use.

To remove and replace the spa pillows:

1. Carefully lift one end of the pillow away from the spa shell.
 2. Continue lifting one end until the pins on the bottom of the pillow are released from the pin retainer on the spa shell. Do the same to loosen other end of pillow.
- IMPORTANT: Just pulling the pillow straight up, and out of the shell recess, will eventually damage the pillow. This abuse is not covered under warranty.**
3. To reinstall the spa pillow, carefully bend the pillow slightly to allow the pins to slip into the pin retainer on the spa shell.
 4. Keeping the pillow slightly bent, slide the other pins (opposite end) onto the pin retainer on the spa shell.
 5. After all the pillow pins are in place, press the pillow down into the recess in the spa shell.

CARE OF THE EXTERIOR

SPA SHELL

Your Saratoga Spa is manufactured with a tough acrylic surface. Some staining or water marking may occur at or above the water surface. Removal of these surface conditions can usually be accomplished with a soft cloth by merely wiping them away. Stubborn stains can be removed first by draining the spa and then using a nonabrasive product. Always thoroughly rinse off any spa shell cleaning agent with fresh water.

IMPORTANT: Keep all cleaners out of the reach of children and use care when applying.

SPA CABINET

The skirt around your Saratoga Spa is manufactured with the finest quality materials available.

WOOD SKIRT

A good quality wood sealer or natural color wood oil should be applied on the wood skirt twice a year to keep your spa skirt looking as good as new. Your Saratoga Spa dealer may stock original factory finish or recommend another sealer that is available in your area.

Note: Discoloration of the wood spa skirt is considered natural and is not covered by the spa surface warranty.

WEATHER ALL SKIRT

The Weather All skirt combines the durability of plastic with the look of professionally finished wood. To remove any stains or dirt simply spray the skirt with water and wipe down with a soft cloth. Weather All is not designed to be stained or resealed.

CARE OF THE SPA COVER

VINYL COVER

Your vinyl thermal spa cover has been designed for your particular spa. Monthly cleaning and conditioning is recommended to maintain its beauty.

To clean and condition the vinyl cover:

1. Remove the cover from the spa and gently lean it against a wall or fence.
2. With a garden hose, spray the cover to loosen and rinse away dirt or debris.
3. Using a large, non-abrasive sponge and using a very mild soap solution (one teaspoon dishwashing liquid with two gallons of water) scrub the vinyl top in a circular motion. Make sure to rinse all soap off the cover before it dries.
4. Scrub the cover's perimeter and side flaps. Rinse clean with water.
5. Rinse off the underside of the cover with water only (use no soap), and wipe it clean with a dry rag.
6. To condition the cover after cleaning, apply a thin film of saddle soap (follow directions on the container) or vinyl conditioning cream.

Important reminders:

- *DO unlock and release all cover locks before attempting to open cover.*
- *DO remove snow buildup to avoid damage of the foam core from the additional weight of the snow (not covered under warranty).*
- *DO lock cover lock straps to secure the cover when the spa is not in use.*
- *DO NOT drag or lift the spa cover using either the flaps, or the cover tie downs.*
- *DO NOT walk, stand, or sit on the cover.*

IMPORTANT:

Whenever the spa is not in use it is essential that the thermal cover be kept in place. When filled this ensures effective temperature maintenance and economical operation. When empty this prevents potential damage to the spas surface finish which can result from excessive heat caused by the sun. This type of damage is specifically excluded from warranty protection. It is recommended that the thermal cover tie downs always be used to discourage access to the spa by unsupervised children and minimize heat loss.

*The spa cover manufacturer handles all warranty claims. Saratoga Spa does not handle any warranty issues on the spa cover.

WINTERIZING YOUR SPA

If you chose not to use your Saratoga Spa during the winter is it recommended to properly winterize your spa. Any damage occurring due to accidental freezing of the spa is not covered under warranty.

The following steps are designed to protect your spa from freezing if followed. For ultimate protection against freeze damage to your spa, contact your local Saratoga Dealer to schedule a winterizing service plan.

1. Turn power off to the spa. Trip RCI breaker.
2. Unscrew panel screws. Remove access panel.
3. Locate the drain valve and attach a garden hose to the drain valve.
4. Open the drain valve and allow the water to drain (Saratoga Spas will drain to the lower suction fittings in the footwell of the spa).
5. Remove filter cartridges and screen adaptors. Clean and store in a dry place.
6. Using a wet/dry shop vac vacuum, soak up the water remaining on the bottom of the spa.
7. Open unions at the heater and at the pump(s). Remove pump(s) from spa. Vacuum up water from return and suction sides of the plumbing on the pump(s). Vacuum any water from heater housing. Leave unions at the heater and at the pump(s) open.
8. Reverse vacuum and blow out each line of the plumbing going into the pump(s).
9. Remove drain plug(s) from pump(s). Vacuum up any water. Leave drain plug(s) open.
10. Place three cups of antifreeze in wet end of pump(s). Reinstall pump(s) with unions loose and drain plug(s) out.
11. Place the vacuum hose down the filter cartridge openings and vacuum up any water from filter compartment.
12. Disconnect the unions at the circulation pump from both the return and suction side of pump.
13. Remove hoses and circulation pump.
14. Vacuum up both suction and return side of the circulation pump.
15. Reverse vacuum and blow out each side of circulation pump. Also, blow out and vacuum any water from the hoses coming into the circulation pump.
16. Re-attach circulation pump and leave hoses unattached.
17. With a shop vac, go to every jet in the spa (including suction fittings) and place vac hose over the face of every jet and vacuum out any water left in the lines. Do the same to the filter housing and filter cartridge openings. Continue to do the same to the heater and the plumbing going into the pump(s).
18. Wipe down spa shell with a soft clean cloth.
19. Place spa cover over spa and lock into place.
20. To restart the spa, follow the normal fill-up procedures. Also, connect all hoses and close all unions. It may be necessary to flush the spa depending on the amount of antifreeze used. Note: In severe cold climates it may be better to leave pump(s) and circulation pump out of the spa for the winter. Store pump(s) and circulation pump in a warm environment to prevent from freezing.

Warning: Do not use ethylene glycol based antifreeze. This type of antifreeze is toxic and can damage the spa surface.

WARNING: IF THESE INSTRUCTIONS ARE NOT FOLLOWED, DAMAGE DUE TO FREEZING WATER IN THE PLUMBING LINES MAY OCCUR AND ARE NOT COVERED UNDER MANUFACTURERS WARRANTY.

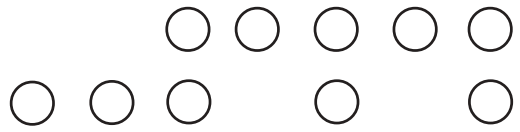

GENERAL INFORMATION

As the owner of a spa, endless hours of entertainment, recreation, and relaxation await you. Caring for your spa will become a routine and pleasant part of your daily activities. You will be able to maintain your spa water and keep your spa equipment in excellent condition. To do so you first must balance your spa's water.

BALANCED WATER

Balanced water ensures spa bathers' safety as well as protecting the spa heater and components from corrosion. Also, balanced water protects the spa surface from unsightly scale deposits which reduce the efficiency of the spa equipment. You can obtain balanced water by correctly adjusting a few chemical components in the water. Specifically, you will need to adjust the pH, total alkalinity and calcium hardness

NOTE: Improper water chemistry can result in product failure and invalidate your warranty.

PH

pH is measured on a scale that runs from 0-14. pH indicates whether water is neutral, acidic, or basic.

The drawing below shows a pH equal to 7.0 is neutral. A pH below this point is acidic and a pH above this point is basic.

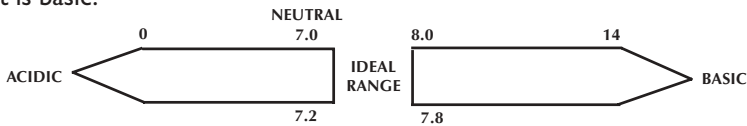

RECOMMENDED RANGE - 7.2 to 7.8

If the pH is too low it can

1. Corrode metal surfaces.
2. Use excess sanitizer.
3. Irritate bathers' skin and eyes.

If the pH is too high it can

1. Deposit scale on surfaces.
2. Contribute to cloudy water.
3. Cause eye irritation.
4. Reduce sanitizer efficiency.

TEST pH WEEKLY

ADJUSTING PH

To raise pH add a granular pH Increaser or sodium carbonate at the rate suggested on the container. To lower pH add a granular pH Decreaser, or sodium bi-sulfate at the rate suggested on the container. After initial application, allow water to circulate approximately 15 minutes on Pump 1 at high speed. Test pH and add second dose if required.

TOTAL ALKALINITY

There are minerals in your spa's water that act as buffering agents. Total alkalinity is the measurement of these alkaline materials that help prevent corrosion and staining. The correct amount of alkalinity in your spa's water will keep the water's pH consistent while allowing for economical pH adjustment when necessary.

Example: At low total alkalinity levels, the water's pH easily drifts, making frequent pH adjustments necessary and more chemical treatment expense.

On the other hand, a high total alkalinity level keeps the water's pH rigidly fixed. If pH adjustment is necessary, you will need unusually large amounts of treatment chemicals to change the water's pH.

RECOMMENDED RANGE - 80 to 120 PARTS PER MILLION (PPM)

POTENTIAL PROBLEMS:

1. pH difficult to maintain. If total alkalinity is too low, pH will drift.
2. Corrosive tendencies. If total alkalinity is too high:
 - pH difficult to adjust (it remains fixed.)
 - Cloudy water.
 - Potential for scaling.
 - High pH and low sanitizer efficiency.

TESTING: WEEKLY

ADJUSTING TOTAL ALKALINITY

Total Alkalinity can be raised with Alkalinity Increaser, or sodium bi-carbonate at the manufacturer's recommendation for dosage.

CALCIUM HARDNESS

Calcium hardness is the amount of dissolved calcium in your spa's water. Too little calcium in the water will etch plaster surfaces, too much will leave deposits on surfaces and equipment.

RECOMMENDED RANGE: 125-150

POTENTIAL PROBLEMS

Calcium Hardness Too Low:

- Some surfaces may be etched.
- May lead to equipment corrosion.

Calcium Hardness Too High:

- May contribute to cloudy water.
- Scaling of surface, piping and equipment.

ADJUSTING CALCIUM HARDNESS

Raise hardness by the addition of calcium chloride. Decrease calcium hardness by draining spa and replacing with water containing lower levels of calcium hardness.

DISINFECTANT

Brominating Tablets, Granular Bromine and Granular Chlorine are popular disinfectants and are particularly well suited to compliment your ozone purification system spa. They are also very suitable products in water with elevated temperatures.

Brominating Tablets and Granular Bromine are effective as a spa water sanitizer and disinfectant. Follow manufacturer's directions for proper dosage. It is recommended to *maintain* an active bromine residual of 2.0 to 4.0 ppm.

Granular Chlorine (Dichlor Dihydrate, Lithium Hypochlorite), is designed to dissolve quickly and completely, provide a steady source of available chlorine to control the growth of algae, kill bacteria and destroy organic contaminants. It is recommended to *maintain* a chlorine residual of between 1.0 and 3.0 ppm.

Non-Chlorine type shock will oxidize or destroy most of the organic contaminants that result from bather load. This quick acting oxidizing shock treatment goes to work almost immediately improving water quality and eliminating irritating wastes and odor. This product is intended to be a shock treatment only, and is not a disinfectant.

SHOCK TREATMENT WITH GRANULAR DISENFECTANT

Adding granular chlorine or bromine disinfectant to the water in amounts much larger than normal is called “*shocking*” the spa and should not be confused with non-chlorine shock. An occasional shock treatment destroys algae, bacteria, and chloramines. After shocking your spa, do not allow bathers to enter the spa until disinfectant levels drop to normal.

WHAT CAUSES LOSS OF DISINFECTANT?

- **ALGAE:** The presence of algae will consume large amounts of disinfectant. If you have an algae problem, the use of an algicide in addition to disinfectant may be necessary.
- **BATHER LOAD:** The greater the number of people using your spa, the more disinfectant you will need to use.
- **IMPROPER pH:** A high pH above 7.8 substantially retards disinfecting. Keep the pH between 7.2 and 7.8.
- **SUNLIGHT:** The sun’s Ultraviolet (UV) rays readily dissipate disinfectant levels.
- **WATER TEMPERATURE:** High water temperature accelerates the loss of disinfectant.
- **WEATHER:** Rain and wind can carry a significant amount of contaminants into your spa.

REMEMBER TO MAINTAIN:

pH 7.2 to 7.8

TOTAL ALKALINITY 80 TO 120 PPM

IF USING BROMINATING TABLETS THE PROPER LEVEL IN DISPENSER

MAINTAIN GRANULAR CHLORINE RESIDUAL LEVEL AT 1.0 TO 3.0 PPM

MAINTAIN BROMINE RESIDUAL LEVEL AT 2.0 TO 4.0

CALCIUM HARDNESS 125-150

NON-CHLORINE SHOCK WEEKLY OR AS NEEDED BASED ON SPA USE

TEST pH, TOTAL ALKALINITY AND CALCIUM HARDNESS WEEKLY

TEST DISINFECTANT DAILY

(Spa test kits are available through your Saratoga Spa Dealer.)

OZONE GENERATORS

The Saratoga Spa Pavilion model comes equipped with an ozone generator. It automatically produces ozone 24 hours a day through our Whisper Clean® System.

WHAT IS OZONE?

Ozone is nature’s natural purifier. It is a chemical known as O₃ and is produced from simple oxygen molecules in our atmosphere. Ozone will breakdown and oxidize oils, greases, suntan lotions, sweat, urea, etc. from spa water more effectively than any other oxidizer commercially available. Ozone also assists chlorine, or bromine, to destroy bacteria and viruses and will do so more effectively. Ozone only leaves simple oxygen in the water as a by-product.

HOW IS OZONE PRODUCED?

Ozone is produced in nature from lightning during electrical storms and is also produced from ultraviolet rays from the sun to form our protective ozone layer. Your ozone converter unit is designed to duplicate this natural sanitizer.

Note: Always follow instructions and dosages listed by chemical manufacturers. Use only spa chemicals in your spa. Do not mix chemicals or add chemicals during bather use.

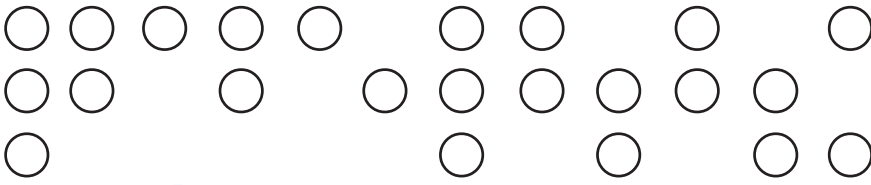

Operations Trouble Shooting Guide

Problem	Probable Cause	Solutions
Spa is not operating	<ul style="list-style-type: none"> • Power failure • RCI breaker tripped • Heater Hi-Limit tripped 	<ul style="list-style-type: none"> • Check power source • Try resetting RCI breaker. If breaker continues to trip, contact your dealer. • Check for dirty filters. <p>Check to see if circulation pump is air bound.</p>
Spa not heating	<ul style="list-style-type: none"> • Dirty filters • Temperature setting too low • Pressure switch out of calibration • Air trapped in circulation line 	<ul style="list-style-type: none"> • Clean the filters • Increase the set temperature • Contact your dealer • Using a garden hose, force water through Whisper Clean® cartridge opening or loosen the bottom heater union to allow trapped air to escape.
Poor or no water flowing through the jets	<ul style="list-style-type: none"> • Dirty filters • Inadequate water level • Air lock 	<ul style="list-style-type: none"> • Clean the filters • Fill spa to 2" above filters • Prime the pump(s) by loosening unions on the pump(s) until air can be heard escaping then tighten unions.
Spa light out	<ul style="list-style-type: none"> • Burned out bulb • Light not turned on 	<ul style="list-style-type: none"> • Replace bulb • Press the light key to desired intensity
Pump(s) turn off unexpectedly	<ul style="list-style-type: none"> • Automatic 15 minute shut off • Pump(s) may have overheated. Built in protective overheat shut off 	<ul style="list-style-type: none"> • Press jets button again to start another 15 minute cycle • Let pump sit for about 10-15 minutes. Allow pump to cool down, keep vented areas on access panel free from blockage.

Operations Trouble Shooting Guide Cont...

Problem	Probable Cause	Solutions
Spa jets/pump(s) turn on automatically	<ul style="list-style-type: none">• Normal power filtration cycle• Summer Setting mode cycle activated• Smart Winter mode cycle activated	<ul style="list-style-type: none">• No action necessary• No action necessary• No action necessary
Not able to operate main control panel	<ul style="list-style-type: none">• Panel may be locked• Panel may have malfunctioned	<ul style="list-style-type: none">• Follow locking features procedures on page 22.• Contact your dealer
Water does not clear up	<ul style="list-style-type: none">• Bad water chemistry• Dirty filter cartridges• Ozone generator not operating • Bromine/chlorine residual levels too low	<ul style="list-style-type: none">• Balance water• Clean or replace filters• Locate ozone generator, look for ultraviolet pure light to be illuminated through window on ozone• Adjust Bromine/chlorine levels. Shock if necessary. May have to replace water

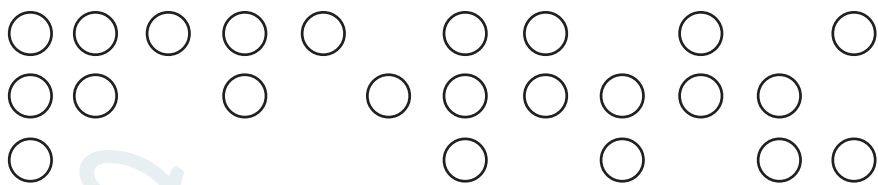

Diagnostic Messages

MESSAGE	MEANING	ACTION
OHH	Overheat-the spa has shut down. One of the sensors has detected 118°F (47.8°C) at the heater	PC Board Heater relay locked. DO NOT ENTER THE WATER. Remove the spa cover and allow water to cool. Once the heater has cooled, reset by pushing any button. If spa does not reset, shut off the power to the spa and call your dealer or service organization.
OHS	Overheat – The spa has shut down. One of the sensors has detected that the spa water is 110°F (43°C).	DO NOT ENTER THE WATER. Remove the spa cover and allow water to cool. At 107°F (41.7°C) the spa should automatically reset. If spa does not reset, shut off the power to the spa and call your dealer or service organization.
ICE	Ice – Potential freeze condition detected at 45°F (6.7°C)	No action required. The pumps and the blower will automatically activate regard less of spa status.
SnA	Spa is shut down. The sensor that is plugged into the Sensor “A” jack is not working.	If the problem persists, contact your dealer or service organization. (May appear temporarily in an overheat situation and disappear when heater cools).
SnB	Spa is shut down. The sensor that is plugged into the Sensor “B” jack is not working.	If the problem persists, contact your dealer or service organization. (May appear temporarily in an overheat situation and disappear when heater cools).

Diagnostic Messages Cont...

MESSAGE	MEANING	ACTION
SnS	Sensors are out of balance. If this is alternating with the temperature it may just be a temporary condition. If the display shows only this message (periodically blinking) the spa is shut down.	If the problem persists, contact your dealer or service organization.
HFL	A substantial difference between the temperature sensors was detected. This could indicate a flow problem.	Check water level in spa. Refill if necessary. If the water level is okay, make sure the pumps have been primed. If problem persists, contact your dealer or service organization.
LF	Persistent low flow problems. (Displays on the fifth occurrence of the "HFL" message within 24 hours). Heater is shut down but other spa functions continue to run normally.	Follow action required for "HFL" message. Heating capacity of the spa will not reset automatically, you may press any button to reset.
drY	Inadequate water detected in heater. (Displays on third occurrence of "dr" message). Spa is shut down.	Check water level in spa. Refill if necessary. If the water level is okay make sure the pumps have been primed. Press any button to reset.
pr	When your spa is first actuated it will go into Priming mode.	The Priming mode will last for up to 4 minutes and then the spa will begin to heat and maintain the water temperature.
sbY	Standby mode has been activated by pressing a button combination on the user panel.	Press any button to leave Standby mode and return to normal operation.

SYSTEM CONNECTIONS AND FUSES

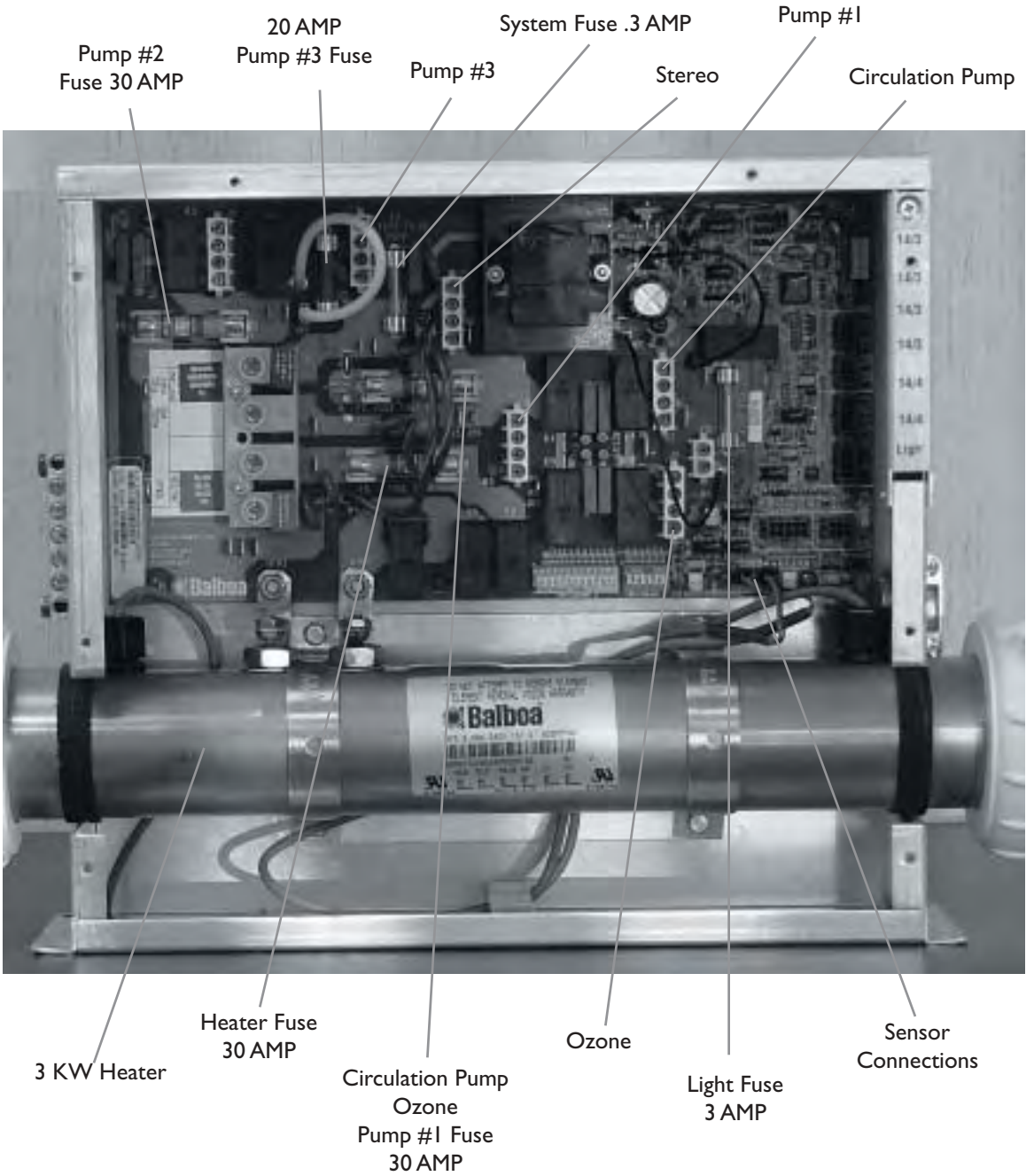

WIRING DIAGRAM

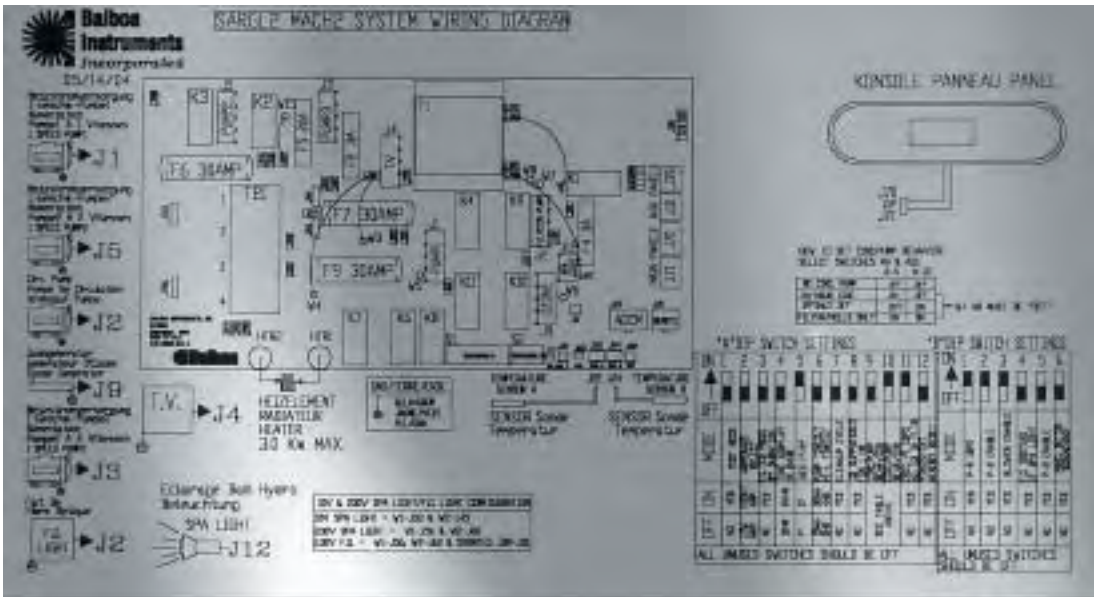

DIP SWITCHES AND JUMPERS



Switchbank A

- 1 - off
- 2 - off
- 3 - off
- 4 - off
- 5 - on
- 6 - off
- 7 - off
- 8 - off
- 9 - off
- 10 - on
- 11 - off
- 12 - off

Switchbank B

- 1 - on
- 2 - on
- 3 - off
- 4 - off
- 5 - on
- 6 - off

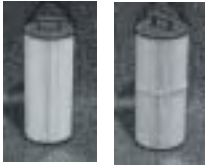

74452 74455

Saratoga Spa Replacement Parts

Saratoga standard Luxury Line filter cartridge
4 3/4" x 12 5/16" 74452

Saratoga Luxury Line Microban® Filter
4 3/4" x 12 5/16" 74455



74450 & 74451

Screen adapters for base of filter cartridge
NPT Screen adapter 74450

ACME Screen adapter 74451

Standard #888 grey pillow 74330



74330

Pavilion grey pillow 74331

Additional Accessories



74331

Covermate I lifts any spa cover up to 96" without hydraulics
149834

Retrofit 22 LED light - displays various color shows
70400



70400

2x3 Cedar spa step-ups offered in three different colors
Red Cedar 084007
Grey Stain 084006
Unstained 08004

Colored light lenses set for your spa light
(1 blue lens and 1 red lens) 31795



31795

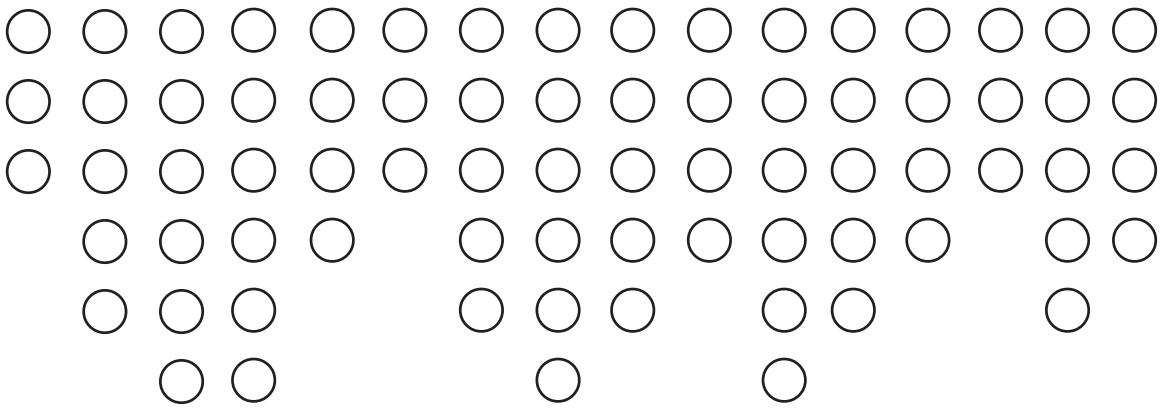

33 Wade Road
Latham, NY 12110
1-800-444-9977
fax: 518-783-0632
www.SaratogaSpa.com
www.SaratogaSpas.com

